

257LE-24-SD

300 Watt, non isolated, single output buck-boost converter with internal decoupling diode

All parameters defined on $T_a=25^{\circ}\text{C}$, $I_{oNom} = 12.5 \text{ ADC}$ and $U_{iNom} = 24\text{VDC}$

ABSOLUTE MAXIMUM RATINGS

parameter	unit	typ
Input peak voltage	VDC	37.00
Feedback protection against overvoltage on the output	VDC	45
Output overvoltage protection	VDC	33.0

THERMAL CHARACTERISTICS

parameter	min to max	typ
Ambient temperature range	$-40^{\circ}\text{C} / +85^{\circ}\text{C}$	
Max. case temperature for thermal shut down [$^{\circ}\text{C}$]		$+90^{\circ}\text{C}$
Storage temperature [device not in operation]	$-10^{\circ}\text{C} / +65^{\circ}\text{C}$	
Relative maximum humidity under storage		75% RH
Storage under worst conditions [in days]		25

COMMUNICATION INTERFACE

parameter	unit	fulfilled	conditions	min to max
Option shut down [left open for operation]		✓		
Shutdown voltage for transformer	VDC		I_{oNom}	-0.2 to 2.8

SPECIALS

parameter	unit	fulfilled	conditions	typ
Switching frequency	kHz			110
Efficiency at light loads	%		$0.25I_{oNom}$	97.00
Efficiency at medium loads	%		$0.5I_{oNom}$	97.00
Efficiency at full loads	%		I_{oNom}	96.00
For active loads or parallel connection		✓		
Drives high capacitive loads		✓		
CC/CV battery load characteristic		✓		
Insulation strength primary to case	VDC			1500

COMPLIANCE

parameter	fulfilled	notes
61000-6-2 [EMC-Immunity standard for industrial environment]	✓	
61000-4-2 [immunity against ESD-electrostatic discharge]	✓	
61000-4-3 [immunity High frequency electromagnetic fields]	✓	
61000-4-4 [immunity against burst - electrical fast transients]	✓	
61000-4-5 [immunity against surge - high energy surges]	✓	
61000-4-6 [immunity against induced, conducted disturbances]	✓	
61000-6-4 [EMC - Emission standard for industrial environment]	✓	
55022<A	✓	

All technical and general information is provided in all conscience. However, completeness and accuracy cannot be guaranteed. Demke recommends to fully test the product in its determined application. Due to permanent improvements to our products, we reserve the right to change specifications at any time and without prior notification and without obligation to update products already supplied. This is a component for professional equipment manufacturers. Read the safety and installation instruction for proper use. Safety aspect and EMC-aspect must be considered in the end application.

257LE-24-SD

300 Watt, non isolated, single output buck-boost converter with internal decoupling diode

INPUT

parameter	unit	conditions	min	typ	max
Input voltage range	VDC	IoNom	10	24	35
Max. input current	A	UiNom		35	
Input start up voltage	VDC	UiNom		9.5	
Undervoltage lockout	VDC	UiNom		8.0	

OUTPUT

parameter	unit	conditions	min	typ	max
Output voltage	VDC	IoNom		24.0	
Minimum required load to obtain the specified output voltage	%	UiNom		0	
Output voltage accuracy	%	IoNom		+/-2.00%	
Output voltage overshoot at initial switch-on	%	IoNom		overdamped	
Rated output power	W			300	

CONTROL

parameter	unit	conditions	min	typ	max
Static line regulation	%	IoNom/UiMin...UiMax		0.10	
Dynamic load change adjusting time	ms	LoadChange 10...90%		0.50	
Dynamic load change deviation to nominal output voltage	V	LoadChange 10...90%		1.50	
Maximum admissible capacitive load	uF	IoNom		infinite	
Initial switch on time	ms	IoNom		50	
Softstart ramp up time	ms	IoNom		15	

All technical and general information is provided in all conscience. However, completeness and accuracy cannot be guaranteed. Demke recommends to fully test the product in its determined application. Due to permanent improvements to our products, we reserve the right to change specifications at any time and without prior notification and without obligation to update products already supplied. This is a component for professional equipment manufacturers. Read the safety and installation instruction for proper use. Safety aspect and EMC-aspect must be considered in the end application.

257LE-24-SD

300 Watt, non isolated, single output buck-boost converter with internal decoupling diode

MECHANICAL parameter

parameter	unit	
Overall dimensions	mm	90x90x26
Weight	g	355

Pin No.	Function	Electrical Determination
1	SD	Shut down
2	Vi+	Input voltage positive
3	Vi-	Input voltage negative
4	Vo-	Output voltage negative
5	Vo+	Output voltage positive

Mechanical dimensions and Pin configuration

All dimensions in mm

Connector type: Flat pin plug 6.3mm

Case: FMC 90x90x26

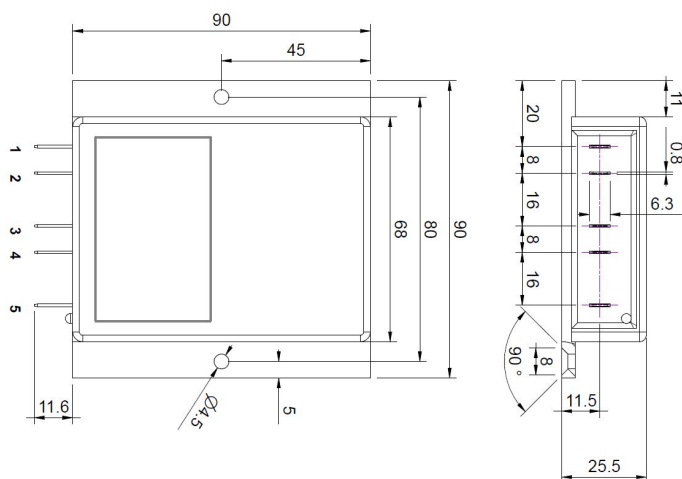

All technical and general information is provided in all conscience. However, completeness and accuracy cannot be guaranteed. Demke recommends to fully test the product in its determined application. Due to permanent improvements to our products, we reserve the right to change specifications at any time and without prior notification and without obligation to update products already supplied. This is a component for professional equipment manufacturers. Read the safety and installation instruction for proper use. Safety aspect and EMC-aspect must be considered in the end application.